

PLAN

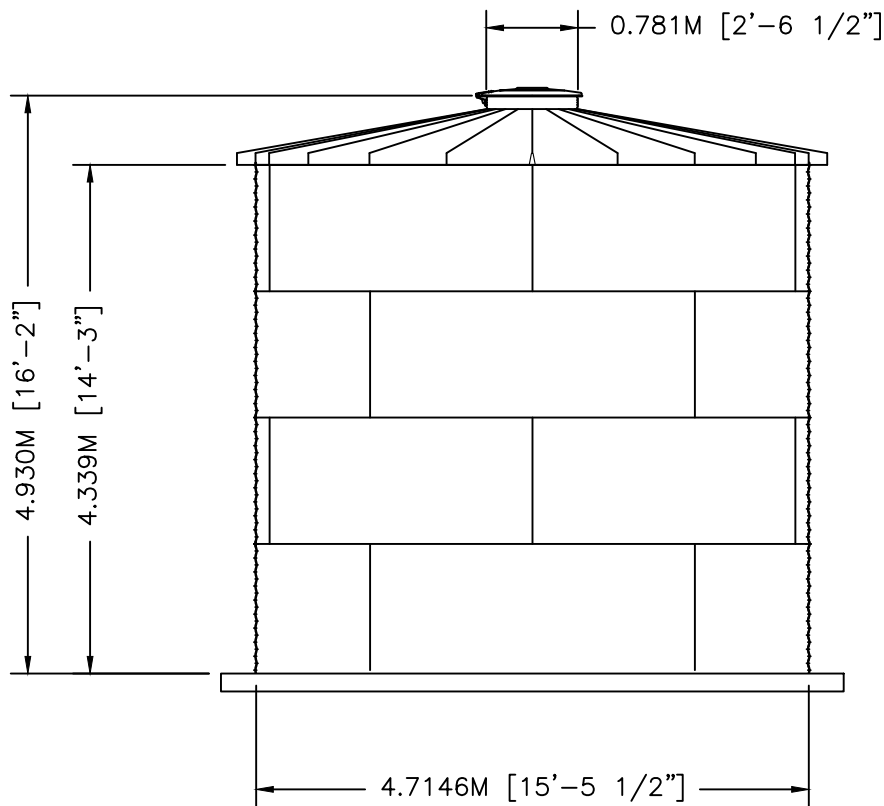

ELEVATION

**STEEL CORE TANK, LLC.**  
**WWW.STEELCORETANK.COM**  
**(844) 225-0881**

	BY	DATE
DWN	XXX	XX/XX/XX
CKD		
ENG		

TITLE STEELCORE WATER TANK SCT-1504-LVR WTU05-04 30"PR 10DEG V-RIB NOMINAL CAPACITY - 73.607 M3 [19,445 GAL]	
DWG. NO. SCT1504-LVR WTU05-04	REV. NO.

THIS DRAWINGS DEPICTED ON THIS PRINT AND INFORMATION CONTAINED HEREIN ARE PROPRIETARY TO STEEL CORE TANK, LLC. AND SHALL NOT BE USED IN WHOLE OR PART WITHOUT WRITTEN CONSENT OF STEEL CORE TANK, LLC. 2015

SIZE: A	SCALE: 3/16"=1'-0"	SHEET 1 OF 1
---------	--------------------	--------------