

PLAN

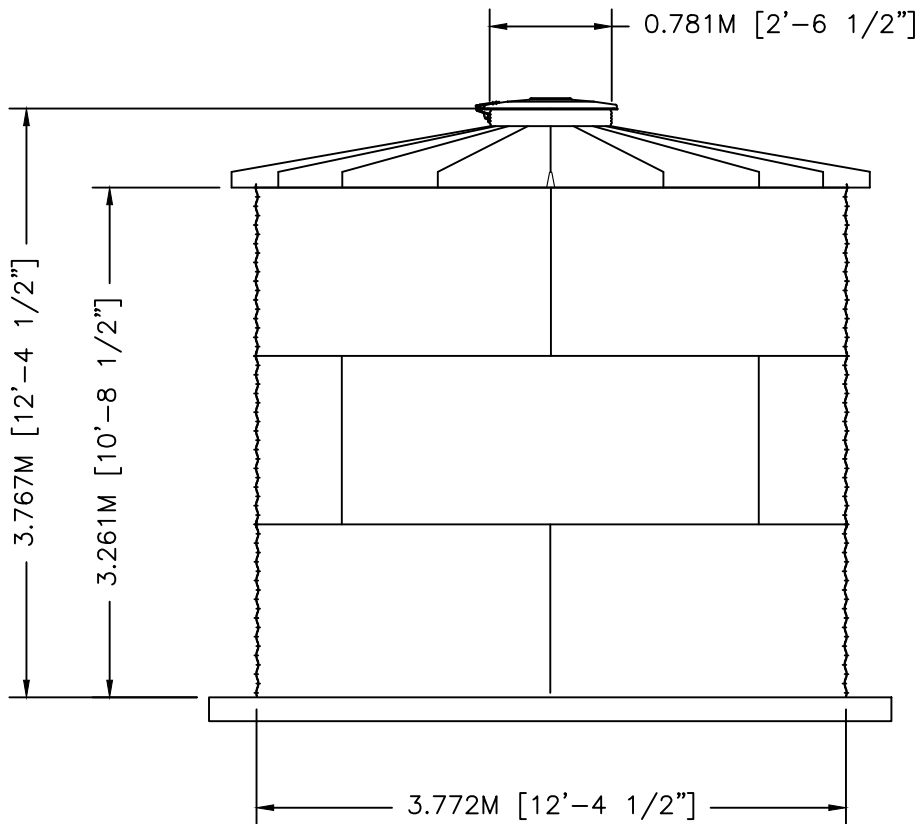

ELEVATION

STEEL CORE TANK, LLC.
WWW.STEELCORETANK.COM
 (844) 225-0881

	BY	DATE
DWN	XXX	XX/XX/XX
CKD		
ENG		

TITLE	STEELCORE WATER TANK SCT-1203-LVR WTU04-03 30"PR 10DEG V-RIB NOMINAL CAPACITY - 35.049 M3 [9,259 GAL]	
DWG. NO.	SCT1203-LVR WTU04-03	REV. NO.

THIS DRAWINGS DEPICTED ON THIS PRINT AND INFORMATION CONTAINED HEREIN ARE PROPRIETARY TO STEEL CORE TANK, LLC. AND SHALL NOT BE USED IN WHOLE OR PART WITHOUT WRITTEN CONSENT OF STEEL CORE TANK, LLC. 2015

SIZE:	SCALE:	SHEET	OF
A	1/4"=1'-0"	1	1